

KACON COLOR MARK SENSOR KC91

- Simple and easy setting by 2 buttons and 3 digit FND
- Customized color balance setting function for better color recognition at customer site.
- 2mm spot size and 15ms sensing speed.

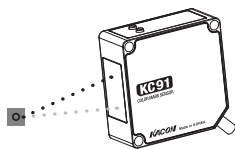

Caution for your safety

- ※ Please keep these instructions and review them before using this unit.
- ※ Please observe the cautions that follow:
 - Warning Serious injury may result if instructions are not followed.
 - Caution Product may be damaged, or injury may result if instructions are not followed.
- ※ The following is an explanation of the symbols used in the operation
 - ⚠ caution : Injury or danger may occur under special conditions.

Warning

- When use this unit for controlling highly affective machinery to human or properties (medical equipment, vehicle, train, airplane, combustion apparatus and entertainment etc.), it is required to install fall-safe device. It may cause serious human injury or a fire, property.
- Please observe voltage rating. It may shorten the life cycle or damage to the product.
- Please check the polarity of power and wrong wiring. It may result in damage to this unit.

General Specification

Teaching distance	9mm ± 0.5mm
Sensing range	Depends on the circumstance of colors combination.
Spot diameter	2mm
Light source (wavelength)	White LED
Power supply voltage	12 - 24VDC ± 10%
Power consumption	Maximum 600mW at 24VDC with 20mA
Control output	NPN output : Black cable PNP output : White cable Load current: 100mA Residual voltage: 2 V max
Indicator	3 digit FND
Protection circuits	Reverse power protection for 5 min
Response time	Maximum 15ms
Ambient illumination	Indoor lamp: 3,000 lx max., Sunlight: 10,000 lx max.
Ambient temperature	Operating: 20 to 60 °C, Storage: 30 to 70 °C (with no icing)
Ambient humidity range	Operating: 35% to 85%, Storage: 35% to 95% (with no condensing)
Insulation resistance	20 MΩ min. (at 500 VDC)
Dielectric strength	1,000 VAC at 50/60 Hz for 1 min
Vibration resistance	10 to 55 Hz, 1.5mm double amplitude for 2 h each in X, Y, and Z directions
Shock resistance	500 m/s ² for 3 times each in X, Y, and Z directions
Degree of protection	IP67 (IEC)
Cable	2m PVC cable (Rohs)
Standard sensing object color (Based on Munsell color index)*	White (N9.5) Black (N2.0) Red (4R 4.5 /12.0) Blue (3PB 5.0 /10.0) Green (3G 6.5 /9.0)

Color balance

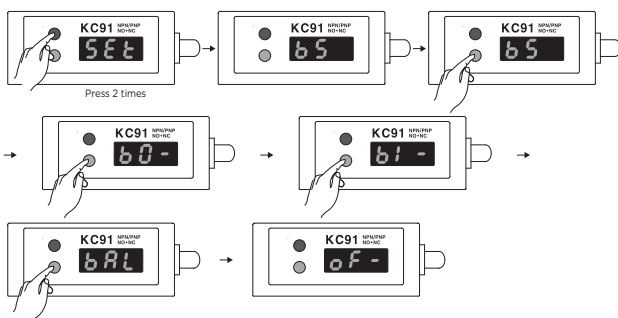

- Press GRAY KEY 2 times till 'b5' is displayed.
 - Place *non-shining white paper or background color*, at the same position of teaching color.
 - Press 'BLUE KEY' till 'bAL' is displayed.
 - Once color balance is done 'bAL' is flicking 3 times and return to normal mode.
- * If you have variety color on background of teachig color, you shall place non-shining white paper. And if the background color is only one, you shall set the color balance on background directly

Caution to set color balance

- KC91 has got default color balance value from factory
- But if you are facing some difficult of distinguish color between background and teaching color, you shall try color balance setting to apply circumstance of teaching color to operation algorithm.
- Also color balance value is not set correctly KC91 shall not operate as its own purpose. So please pay attention direction of manual when you set the color balance.
- You shall return to default color balance value by factory reset function.

OUTPUT NO/NC

① no mode (Release a output signal for teaching color.)

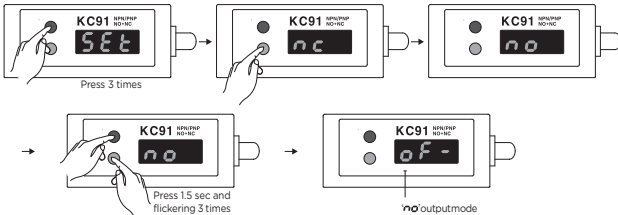

② nc mode (It is reverse signal of no. It release output signal for background of teaching color.)

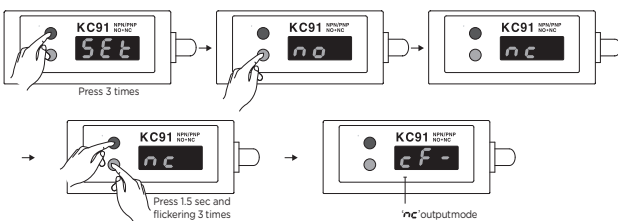

- Press 'GRAY KEY' 3 time still 'no' or 'nc' is displayed.
- Press 'BLUE KEY' to change mode 'nc' or 'no' and press BLUE and GRAY keys for 1.5sec to confirm the changed output mode. If setting is done 'nc' or 'no' is flicking 3 times and return to normal mode.

User guide

Key configuration

No.	Part	Operation
①	GRAY KEY	Parameter Setting
②	BLUE KEY	Color teaching
① + ②	GRAY KEY + BLUE KEY	- Release key lock mode - Parameter setting confirm
③	FND	Normal mode display indication

Display configuration

No.	Item	Display description
①	Output type	NO : 0, NC : C
②	Key locking	KEY LOCK : L, KEY LOCK OFF : F
③	Output signal	Output ON : 0, Output OFF : -
	No teaching value	no indication

Color teaching method

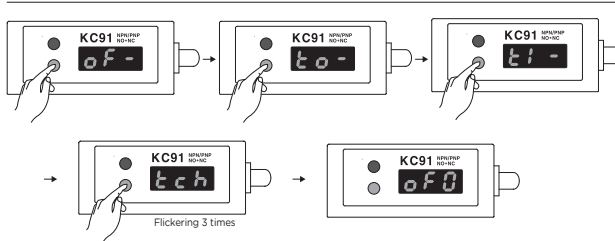

- Install the sensor and fix at 9mm distance from target color.
- Press 'BLUE KEY' 3 sec until indicating 'tch'.
- If teaching is done, display shall indicate status of sensor.

Warning

- Please check it can distinguish background and target color when color teaching is done.
- If you detection glossy object, Mount the sensor at an angle of 10° to 20°, as following diagrams (①, ②).
- If you adjust color balance in balancing mode, you shall need to teach color again.
- When you have done the teaching, key locking is recommended to prevent in case of changing teaching values by event of push keys.

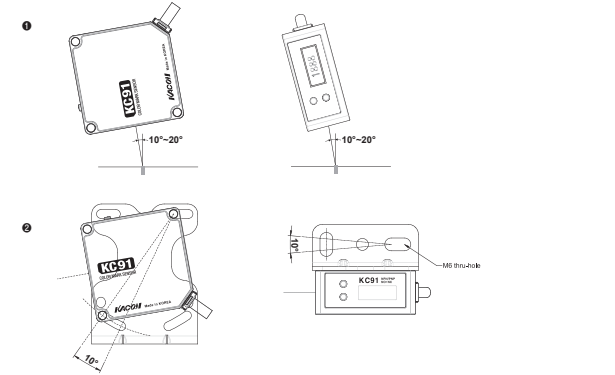

Factory Reset

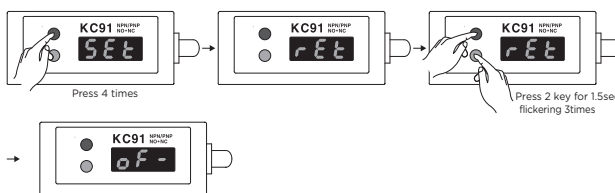

- Press 'GRAY KEY' 4 times till 'rE' is displayed.
- Press 2 key for 1.5sec to confirm factory reset
- Once factory reset is done, 'rE' is flicking 3 times and return to normal mode.

Dimension and wiring

Connection Diagram

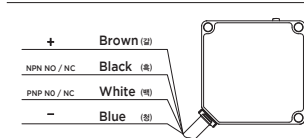

Dimension / KC91

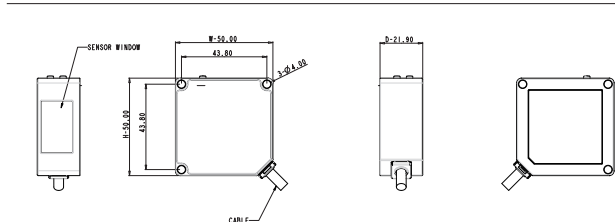

Dimension / Bracket

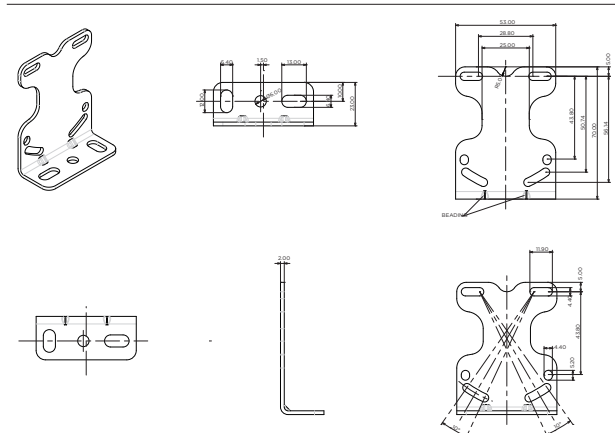

Teaching parameter setting

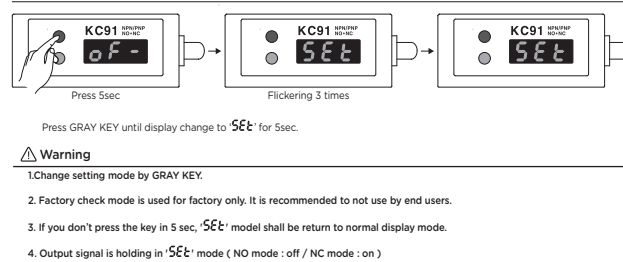

Warning

- Change setting mode by GRAY KEY.
- Factory check mode is used for factory only. It is recommended to not use by end users.
- If you don't press the key in 5 sec, '5E' model shall be return to normal display mode.
- Output signal is holding in '5E' mode (NO mode : off / NC mode : on)

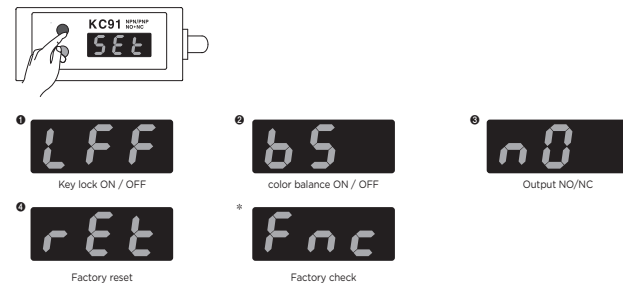

KEY LOCK SETTING

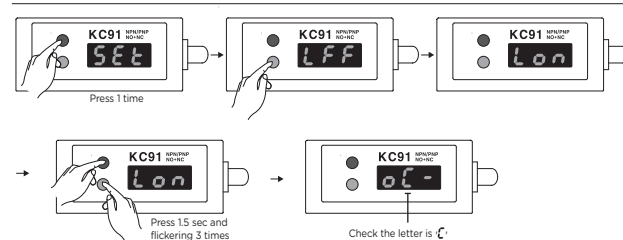

- Get into '5E' mode and change to 'LFF' by GRAY KEY input 1 time.
- Change display from 'Lon' to 'LFF' by BLUE KEY input and press 'BLUE and GRAY Keys for 1.5 sec to confirm the Key Lock setting.

Release Key Lock

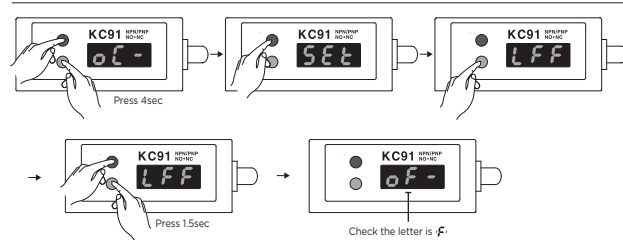

- Please BLUE and GARY keys for 4 sec until '5E' is indicated.
- Press 'GRAY KEY' to change from '5E' to 'Lon' and press 'BLUE KEY' to change display from 'Lon' to 'LFF'.

Precautions for Safe Use

General Precautions

For precautions on individual products, refer to the Safety Precautions in individual product information.

- Warning.
 - These products cannot be used in safety devices for presses or other safety devices used to protect human life.
 - These products are designed for use in applications for sensing workpieces and workers that do not affect safety.
- Precautions for Safe use
 - To ensure safety, always observe the following precautions.

Wiring Instruction

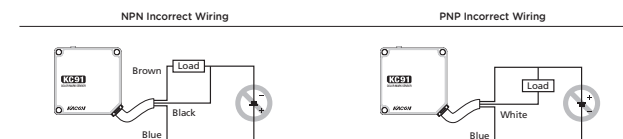
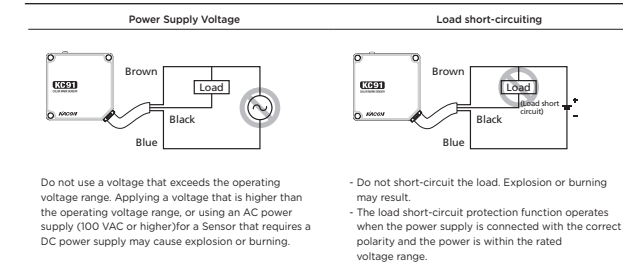

Be sure that the power supply polarity and other wiring is correct. Incorrect wiring may cause explosion or burning.

Precaution for Safe use

- Settings
 - Power Reset Time
- The Sensor is ready to operate after output signal when the power is connected.
- If the load and Sensor are connected to independent power supplies respectively, Please be sure to turn ON the Sensor before turning the load ON.
- Connections
 - Secure the connector cover by hand. Do not use any pliers, otherwise the connector may be damaged.
 - The proper tightening torque range is between 0.3 and 0.4 N · m. Be sure to tighten the connector securely, otherwise the specified degree of protection may not be maintained or the connector may be disconnected due to vibration.
- Mounting
 - Sensor Mounting
 - Use M4 screws to mount the sensor and tighten each screw to a maximum torque of 0.5 N · m.
- Cable
 - The cable material is normal PVC so it may not suitable for oil resistance and regular moving circumstance.

KACON
Industrial controls & Automation
#150-55 KAJWA, SEO-GU, INCHEON, REPUBLIC OF SOUTH KOREA
T 82.32.575.4036-41 F 82.32.576.9300
www.kacon.co.kr
affiliated companies myplanet KASYS OTAX