

7inch wide screen, TFT Color LCD type

Graphic panel + PLC function Logic panel LP-S070

NEW

■ Features

- Supports cost reducing, space saving, easy control by PLC+HMI+I/O module integration
- Adopts 7 inch wide TFT LCD for realizing True Color with 16,777,216 colors
- Analog touch method : Free tag arrangement than matrix touch method
- Supports basic I/O of input 16 points, output 16 points
- Supports several device (auxiliary device 10K Word, data device 10K Word, etc)
- Built-in large capacity memory (program memory : 8,000 step, drawing memory : 16MB)
- Built-in position control function : Provides simultaneous output for max.100kHz pulse 2 points
- Easy software upgrade at website
 - (1) LP firmware file
 - (2) GP Editor (drawing program)
 - (3) SmartStudio (Logic program)
 - (4) Additional protocol
 - (5) Language and font, etc
- Data logger function : Supports data gathering and backup of controller
- Supports variable image library
- Enables to monitor multi station and multi channel at the same time
- Supports several interface : Easy to connect various external devices with RS232C 2 ports and RS232C/RS422 multi communication port : Enables to extension additional external I/O (when connecting Autonics ARM Series, one communication cable enables to extend 64-point per an address, up to 31-address)



7 inch TFT Color LCD

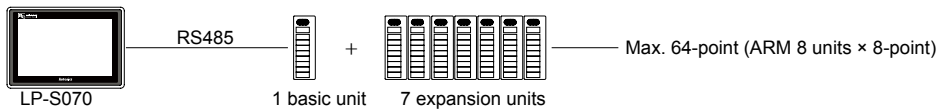

- Supports several fonts: Supports window true type and several bitmap font (Selectable)
- Device monitoring function : Enables to monitor/control variable of connected control through communication port
- Printer/Barcode reader connection: Enables to print out alarm history, to read barcode

⚠ Please read "Caution for your safety" in operation manual before using.



■ Manual

Visit our webwite(www.autonics.com) to download 'GP Editor user manual' or 'SmartStudio user manual', 'SmartStudio programing manual', 'LP Series command manual', 'LP-S070 user manual', 'GP, LP user manual for communication'.

• GP Editor user manual

It describes how to write screen data, and is about related usage of LP-S070 HMI function.

• SmartStudio user manual, SmartStudio programming manual, LP Series command manual

It contains install method and usage, commands, etc of SmartStudio.

• GP, LP user manual for communication : It describes connection for external devices such as PLC.

• LP-S070 user manual : It describes general information on the installation and usage of LP-S070 and system Contents.

■ Ordering information

Model	Item	Series	Monitor size	Display unit	Color	Power supply	Interface	Module	I/O composition	I/O connector
LP-S070-T9D6-C5T	Logic panel	S series	7 inch	TFT Color LCD	16,777,216 color	24VDC	RS232C, RS422, USB HOST USB DEVICE, Ethernet	All-in-one type	IN: 16points, OUT: 16points	Terminal block connector
LP-S070-T9D6-C5R										Ribbon cable connector
LP-S070-T9D7-C5T							Terminal block connector			
LP-S070-T9D7-C5R							Ribbon cable connector			

Specifications

Model	LP-S070-T9D6-C5T	LP-S070-T9D6-C5R	LP-S070-T9D7-C5T	LP-S070-T9D7-C5R
I/O connector type	Terminal block connector	Ribbon cable connector	Terminal block connector	Ribbon cable connector
Power supply	24VDC			
Allowable voltage range	90 to 110% of power supply			
Power consumption	Max. 7.2W			
Graphic drawing performance	LCD type	7 inch TFT Color LCD		
	Resolution	800×480 dots		
	Display area	152.4mm×94.44mm		
	Color	16,777,216 color		
	LCD view angle	Within each 50°/ 60°/ 65°/ 65° of top/bottom/left/right		
	Backlight	White LED		
	Brightness	Adjustable by software		
Graphic drawing performance	Language*1	English, Korean		
	Text	<ul style="list-style-type: none"> • Vector font • 6×8, 8×8 ASCII character, high definition numbers • 8×16 ASCII characters, 16×16 regional characters(1 to 8 times bigger for width, 0.5 to 5 times bigger for height) 		
	Graphic drawing memory	16MB		
	Number of user screen	500 pages		
	Touch switch	Analog touch		
Control performance	Command	Basic command : 28, application command : 233		
	Program capacity	8K step		
	Processing time	Average : Approx. 2us/basic command, application command		
	I/O control type	Batch processing		
	Computer control mode	Repeated-doubling method, interrupt processing		
	Device range	*Refer to LP-S070 user manual		
	Special function	Positioning function *Refer to LP-S070 user manual		
Serial interface	Asynchronous method: Each port of RS232C, RS422			
	Each port of RS232C, RS422		Two ports of RS232C	
USB interface	Each of USB Host, USB Device(Version 1.1)			
Ethernet interface	IEEE802.3(U), 10/100Base-T			
Real-time controller	RTC embedded			
Battery life cycle	Approx. 3 years at 25°C			
Insulated resistance	Min. 100MΩ(at 500VDC megger)			
Ground	3rd grounding(max. 100Ω)			
Noise immunity	The square wave noise(pulse width 1μs) by the noise simulator with ± 0.5kV			
Withstanding voltage	500VAC 50/60Hz for a minute			
Vibration	Mechanical	0.75mm amplitude at frequency of 10 to 55Hz(for 1 min.) in each of X, Y, Z directions for 1 hour		
	Malfunction	0.5mm amplitude at frequency of 10 to 55Hz(for 1 min.) in each of X, Y, Z directions for 10 min.		
Shock	Mechanical	300m/s ² (approx. 30G) in each of X,Y,Z directions for 3 times		
	Malfunction	100m/s ² (approx. 10G) in each of X,Y,Z directions for 3 times		
Environment	Ambient temperature	0 to 50°C, storage: -20 to 60°C		
	Ambient humidity	35 to 85%RH, storage: 35 to 85%RH		
Protection	IP65F(for front panel)			
Accessory	Fixing bracket: 4EA, Battery(included)			
Approval	CE			
Unit weight	Approx. 540g			

*1: Language can be customized.

※Environment resistance is rated at no freezing or condensation.

Input/Output performance

Input performance		Output performance	
Input point	16 points	Output point	16 points
Insulation method	Photo coupler insulation	Insulation method	Photo coupler insulation
Voltage range	19.2 to 28.8VDC	Voltage range	19.2 to 28.8VDC
Rated input voltage	24VDC	Rated input voltage	24VDC
Input resistance	Contact X0 to X5: Approx. 10mA Contact X6 to XF: Approx. 4mA	Max. load current	0.1A/1point, 1.6A/1COM
Input resistance	Contact X0 to X5: 2.2kΩ, Contact X6 to XF: 5.6kΩ	Max. voltage falling when ON	Max. 0.2VDC
Response time	1ms	Response time	1ms
Common method	16 points/1COM	Common method	16 points/1COM
Acceptable wire	0.3 to 0.7mm ²	Acceptable wire	0.3 to 0.7mm ²

(A)	Photo electric sensor
(B)	Fiber optic sensor
(C)	Door/Area sensor
(D)	Proximity sensor
(E)	Pressure sensor
(F)	Rotary encoder
(G)	Connector/Socket
(H)	Temp. controller
(I)	SSR/Power controller
(J)	Counter
(K)	Timer
(L)	Panel meter
(M)	Tacho/Speed/Pulse meter
(N)	Display unit
(O)	Sensor controller
(P)	Switching mode power supply
(Q)	Stepper motor& Driver&Controller
(R)	Graphic/Logic panel
(S)	Field network device
(T)	Software
(U)	Other

■ Functional description

Figure display	Line, rectangle, circle, text, bitmap	
Tags	Numeral display	Displays the designated device as numerical value.(decimal, hexadecimal, octal, binary, real number)
	ASCII display	Displays the designated device value as ASCII character.
	Time display	Displays current time or date.
	Alarm history	Registers alarm history.
	Alarm list	Displays generated (not backed up) alarm.
	Comment display	Displays the designated comment as device status or value.
	Lamp	Displays lamp as device status.
	Part display	Displays the designated parts as device status and value.
	Line graph	Displays several device values with a graph of broken line.
	Trend graph	Displays change of device value for time with a graph of broken line.
	Bar graph	Displays a device value with a bar graph.
	Statistic graph	Displays a ratio of several device values with pie graph.
	Panel meter	Displays a device value as panel meter.
	Touch key	Screen is switched, word/bit device values are set when it touched.
	Numeral input	Configures user input value in device.
	ASCII input	Configures user input ASCII code value in device.
System information function	Monitors/Controls LP operation from PLC.	
Recipe function	Reads/Writes several PLC device collectively.	
Security function	Only acceptable user can observe/operate important data.	
Barcode read function	Connects barcode reader, read barcode.	
Floating alarm function	Warning message is floated when alarm is generated.	
Time operation	Specific bit device is ON/OFF for designated day and time.	
Overlap window	Available to form dynamically overlapping another base screen on the base one.	

■ Dimensions

(unit : mm)

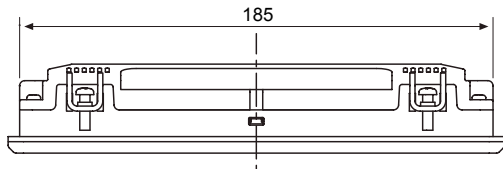

● Panel cut-out

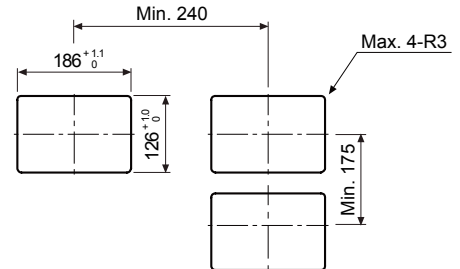

※ Panel thickness : Max. 4mm

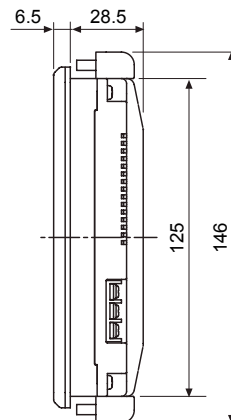
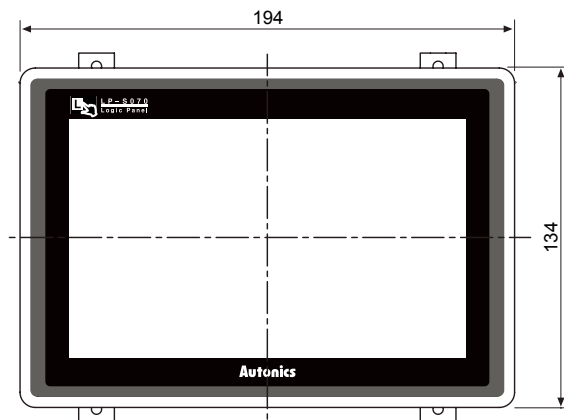

● Fixing bracket

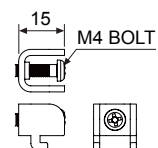

Part description

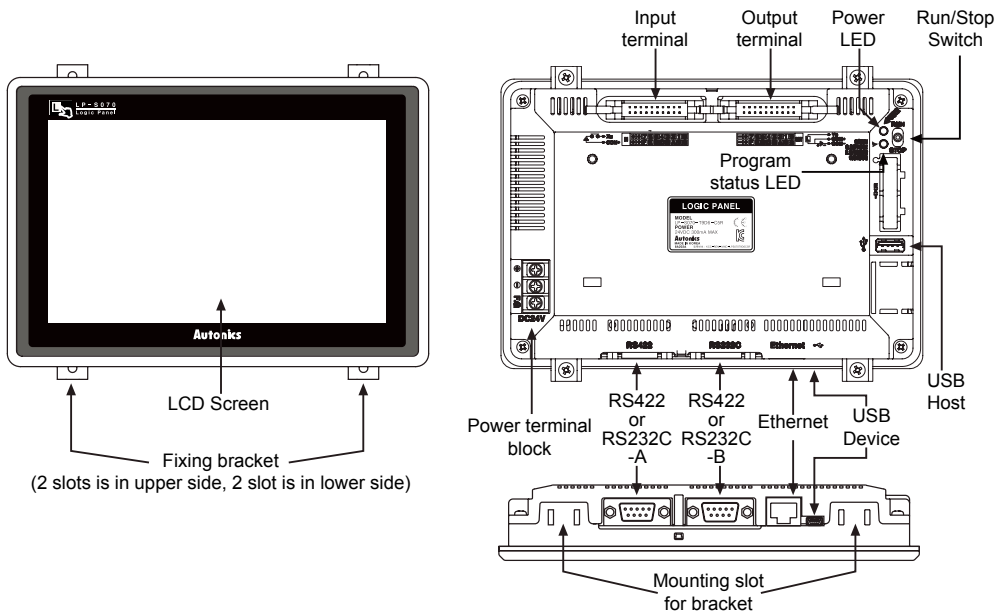

- Ethernet port : For connecting LAN cable and hub, use direct cable, and for connecting PC directly, use cross cable.
- USB Device : It is used to upload and download project(It is required to install USB driver on PC), and when connect to PC, it can be used as a USB memory(PC recognizes it as a removable disk).
- USB Host: It used to manage data and upgrade firmware.
- RS232C, RS422 port: For more information, refer to R-32 page and 'Serial interface' of GP/LP common features.

Installation

1. Set LP-S070 in panel.
2. Set fixing brackets in 4 slots(2 slots is in upper side, 2 slots is in lower side).

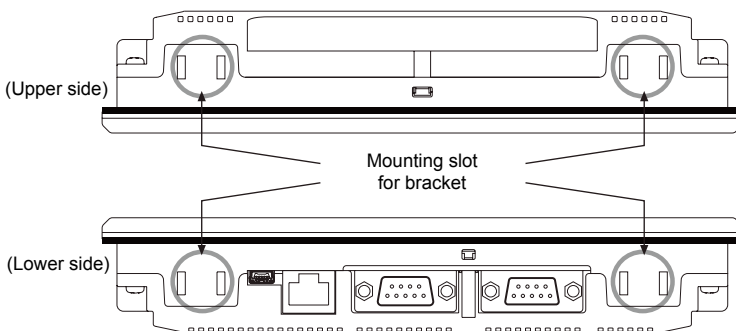

3. Tighten fixing bracket with M4 screw driver and tightening torque is 0.3 to 0.5N·m.

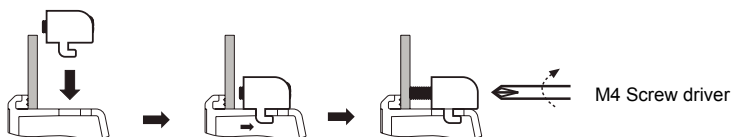

(A)	Photo electric sensor
(B)	Fiber optic sensor
(C)	Door/Area sensor
(D)	Proximity sensor
(E)	Pressure sensor
(F)	Rotary encoder
(G)	Connector/Socket
(H)	Temp. controller
(I)	SSR/ Power controller
(J)	Counter
(K)	Timer
(L)	Panel meter
(M)	Tacho/ Speed/ Pulse meter
(N)	Display unit
(O)	Sensor controller
(P)	Switching mode power supply
(Q)	Stepper motor& Driver&Controller
(R)	Graphic/ Logic panel
(S)	Field network device
(T)	Software
(U)	Other

LP-S070

Input-Output wiring

LP-S070-T9D6(7)-C5R

• Input wiring(source type input module)

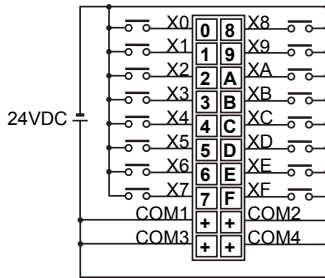

• Output wiring(sink type output module)

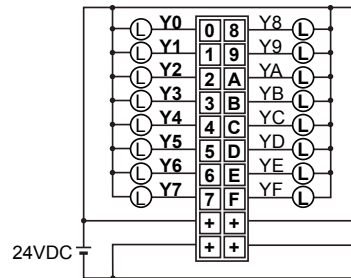

LP-S070-T9D6(7)-C5T

• Input wiring(source type input module)

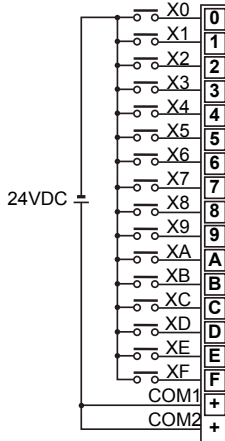

• Output wiring(sink type output module)

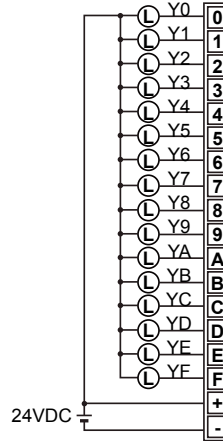

※Check the pin number of the case before wiring.

Sold separately

I/O terminal block and I/O cable

Suitable I/O terminal block	INPUT/OUTPUT	Suitable I/O cable
AFS-H20 (Interface terminal block)	INPUT	CJ-HPHP20-V1N□-1ANR
	OUTPUT	
ABS-H16PA(TN)-NN (Relay terminal block)	OUTPUT	CJ-HPHP20-V1N□-1APR
AFE4-H20-16LF (Sensor connector terminal block)	INPUT	CJ-HPHP20-V1N□-1BNR
	OUTPUT	CJ-HPHP20-V1N□-1APR
—	—	CJ-HP20-VP□-R (OPEN type cable)
		CJ-HP20-VP□-L (OPEN type cable)

※It is only for ribbon cable connector (hirose connector) type.

※"□" is for cable length. (Basic specification 010 : 1m, 020 : 2m, the others are option)

※For more information, refer to "I/O terminal block & cable catalog".

Communication cable (RS232C, RS422 port)

For serial connectable cable to connect PLC and external devices, refer to the R-32 page for "GP/LP communication cable".