

KN-2000W Series

Features

- High accuracy with 16bit ADC ($\pm 0.2\%$ F.S.)
- Max. display range: -19999 to 19999
- Multi-input
 - : Thermometer 12 types, RTD 5 types, analog (mV, V, mA) 6 types
- Auto display color change function (for error or alarm)
- Various output options:
 - : 4 or 2 alarm output, 4-20mA transmission output (isolated), RS485 communication output
 - ※ Full output option model is available. (4 alarm output + RS485 communication output + transmission output)
- Various functions
 - : High/Low peak monitoring, sensor break alarm output (burn-out), input correction, digital input (DI), user input range, display scale, transmission output scale, etc.
- Built-in power supply for sensor (24VDC)



⚠ Please read "Safety Considerations" in operation manual before using this unit.

Ordering Information

KN-2	0	0	0	W	Size	W	DIN W96×H48mm
					Power supply	0	100-240VAC 50/60Hz
						1	24VDC
					Option output	0	No option
						1	Transmission output (4-20mA) ^{※1}
						4	RS485 communication output
						5	Transmission output (4-20mA) + RS485 communication output
					Alarm output	0	No alarm output
						2	Alarm output: 2
						4	Alarm output: 4
					Item	KN-2	Multi Indicator

※1: For transmission output(4-20mA), select one between transmission output+alarm output 2 or transmission output+alarm output 4.

Dimensions

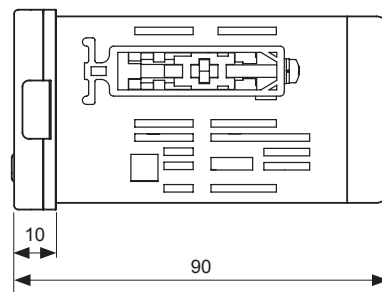
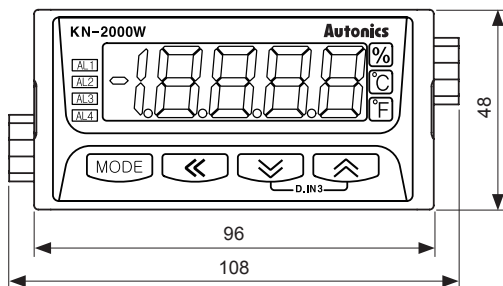

(unit: mm)

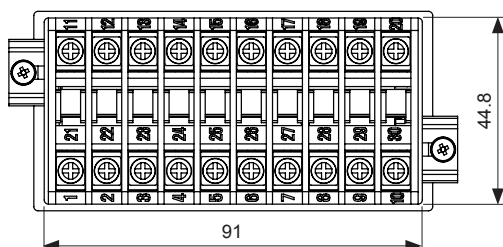

• Panel cut-out

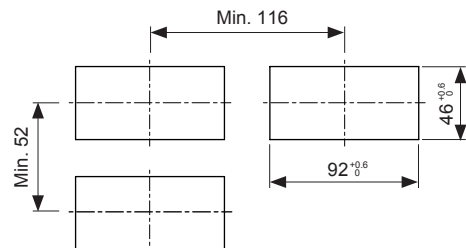

Connections

• KN-20□□W

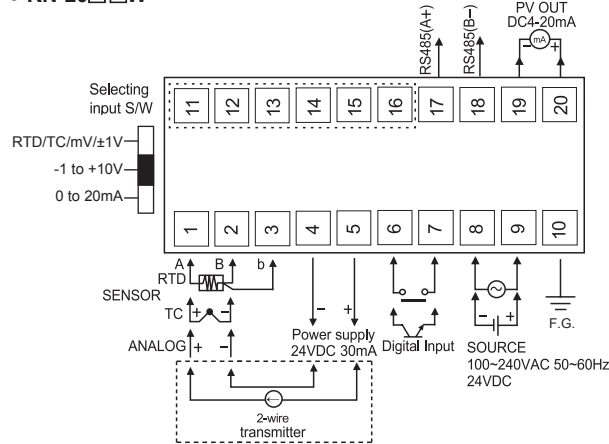

• KN-22□□W

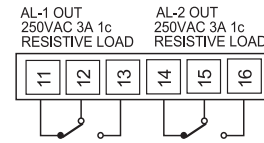

• KN-24□□W

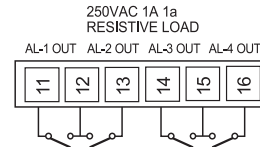

Specifications

Series	KN-2000W	
Power supply	AC voltage	100-240VAC~ 50/60Hz
	DC voltage	24VDC=
Allowable voltage range	90 to 110% of rated voltage	
Power consumption	AC voltage	Max. 8VA
	DC voltage	Max. 3W
Display method	4 ½-digit, 7-segment LED display (selectable red, green, yellow) method	
Character size	W10×H17mm	
Input type	RTD	JPt100Ω, DPt100Ω, DPt50Ω, Cu50Ω, Cu100Ω (5 types)
	Thermocouple	K, J, E, T, R, B, S, N, C (W5), L, U, PLII (12 types)
	Analog	· Voltage: ±1.0000V, ±50.00mV, ±200.0mV, -1.000-10.000V (4 types) · Current: 4.00-20.00mA, 0.00-20.00mA (2 types)
Digital input	· Contact input: max. 2kΩ in ON, min. 90kΩ in OFF · Non-contact input: residual voltage max. 1.0V in ON, leakage current max. 0.03mA in OFF · Outflow current: approx. 0.2mA	
Sub output	Alarm output	· 2-point: relay contact capacity 250VAC~ 3A 1c · 4-point: relay contact capacity 250VAC~ 1A 1a
	Transmission output	ISOLATED DC4-20mA (PV transmission) load resistance max. 600Ω
	Communication output	RS485 (Modbus RTU)
Display accuracy	±0.2% F.S. ±1-digit (25±5°C) ±0.3% F.S. ±1-digit (-10 to 20°C, 30 to 50°C) In case of thermocouple and below -100°C input, [±0.4% F.S.] ±1-digit ※TC-T, TC-U is min. ±2.0°C	
Setting method	Set by front keys, or RS485 communication	
Alarm output hysteresis	Set ON/OFF interval (1 to 999-digit)	
Sampling cycle	Analog input: 100ms, temperature sensor input: 250ms	
Dielectric voltage	2000VAC 50/60Hz for 1 min (between input terminal and power terminal)	
Vibration	0.75mm amplitude at frequency 5 to 55Hz (for 1 min) in each X, Y, Z direction for 2 hours	
Relay life cycle	2-point	Mechanical: min. 10,000,000, electrical: min. 100,000 (250VAC 3A resistance load)
	4-point	Mechanical: min. 20,000,000, electrical: min. 500,000 (250VAC 1A resistance load)
Insulation resistance	Over 100MΩ (at 500VDC megger)	
Noise immunity	±2kV the square wave noise (pulse width 1μs) by noise simulator	
Memory retention	Approx. 10 years (non-volatile semiconductor memory type)	
Environment	Ambient temperature	-10 to 50°C, storage: -20 to 60°C
	Ambient humidity	35 to 85%RH, storage: 35 to 85%RH
Approval	CE	
Weight ^{※1}	Approx. 332g (approx. 200g)	

※1: The weight includes packaging. The weight in parenthesis is for unit only.

※Environment resistance is rated at no freezing or condensation.

A. Recorders

B. Indicators

C. Converters

D. Controllers

E. Thyristor Power Controllers

F. Pressure Transmitters

G. Temperature Transmitters

H. Accessories

KN-1000B

KN-2000W

KN-2000W Series

Input Type and Range

◎ Input type selection switch

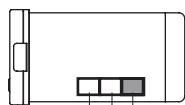

- 0-20mA: Select it for 0(4)-20mA input
- -1-10V: Select it for -1-10V input
- TD/TC/mV/±1V: Select it for RTD, TC temperature sensor or ±1V, mV input

This unit is multi input product. Select the proper input with the input type selection switch and select this input type in $I_n - P$ in program mode. The setting of input type selection switch and the input type $I_n - P$ parameter should be same and it can display the proper measurement value. Factory default is 4-20mA.

Input type	Parameter	Input range (°C)	Input range (°F)	
Thermocouple	K(CA)	$E C - E$	-200.0 to 1350.0	-328 to 2462
	J(IC)	$E C - J$	-200.0 to 800.0	-328.0 to 1472.0
	E(CR)	$E C - E$	-200.0 to 800.0	-328.0 to 1472.0
	T(CC)	$E C - E$	-200.0 to 400.0	-328.0 to 752.0
	R(PR)	$E C - r$	0.0 to 1750.0	32 to 3182
	B(PR)*	$E C - b$	400.0 to 1800.0	752 to 3272
	S(PR)*	$E C - S$	0.0 to 1750.0	32 to 3182
	N(NN)*	$E C - n$	-200.0 to 1300.0	-328 to 2372
	C(W5)*	$E C - C$	0 to 2300	32 to 4172
	L(IC)*	$E C - L$	-200.0 to 900.0	-328.0 to 1652.0
	U(CC)*	$E C - U$	-200.0 to 400.0	-328.0 to 752.0
	Platinel II*	$E C - P$	0.0 to 1390.0	32 to 2534
RTD	Cu50Ω*	$C U 5 0$	-200.0 to 200.0	-328.0 to 392.0
	Cu100Ω*	$C U 1 0$	-200.0 to 200.0	-328.0 to 392.0
	JPt100Ω	$J P t . 1$	-200.0 to 600.0	-328.0 to 1112.0
	DPt50Ω	$d P t . 5$	-200.0 to 600.0	-328.0 to 1112.0
	DPt100Ω	$d P t . 1$	-200.0 to 850.0	-328.0 to 1530.0
Analog	Current	0.00 - 20.00mA	$A . n A 1$	-19999 to 19999 (display range depends on the decimal point position)
		4.00 - 20.00mA	$A . n A 2$	
	Voltage	-50.00 - 50.00mV	$A . n u 1$	
		-200.0 - 200.0mV	$A . n u 2$	
		-1.0000 - 1.0000V	$A - u 1$	
-1.000 - 10.000V	$A - u 2$			

※Above input types which have the * mark are not displayed.

※To display the above input types, supply the power with pressing the **MODE** key.

Unit Descriptions

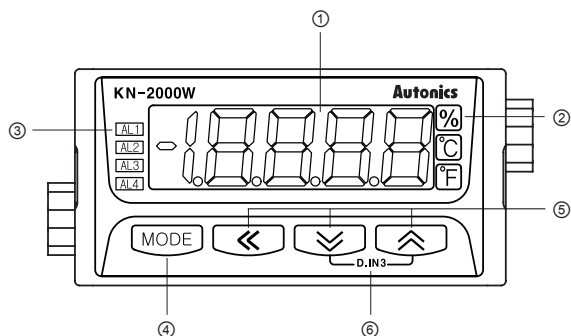

① Display part (red)

- Run mode: Displays current measurement value.
- Parameter set mode: Displays parameter and SV.

② Unit indicator: Displays the set unit.

③ Alarm output indicator: Turns ON when the alarm is ON.

④ **MODE** key: Used to enter parameter set mode, move to parameters, save SV and return to RUN mode.

⑤ \leftarrow , \downarrow , \uparrow key: Used to change parameter SV.

⑥ **D.IN3**: Press the \leftarrow and \uparrow keys for 3 sec at the same time, it operates the set function (alarm clear, display hold, zero-point adjustment) at [$d I - E$] at program mode.

Functions

Alarm [AL-1, AL-2, AL-3, AL-4]

This product has 2 or 4 alarms to operate individually when the value is too high or low. Alarm function is set by the combination of alarm mode and alarm option.

To clear alarm, use digital input function (setting $d1-E$, $d1-E$ as $AL-RE$) or turn the power OFF and ON.

※For the model (KN-20□□W) without alarm output, these parameters are not displayed.

AL1A

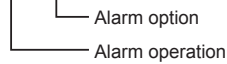

Alarm operation

Mode	Name	Alarm operation	Descriptions
AL0	—	—	No alarm operation
AL1	High limit alarm		PV ≥ alarm temperature, alarm is ON
AL2	Low limit alarm		PV ≤ alarm temperature, alarm is ON
SBAL	Sensor break alarm	—	It will be ON when it detects sensor disconnection. Sensor break alarm does not have alarm option.

※ H: Alarm output hysteresis

Alarm option

Mode	Name	Descriptions
AL1A	Standard alarm	If it is an alarm condition, alarm output is ON. Unless an alarm condition, alarm output is OFF.
AL1b	Alarm latch	If it is an alarm condition, alarm output is ON. Before clearing the alarm, an ON condition is latched. (holding the alarm output)
AL1c	Standby sequence	First alarm condition is ignored. From the second alarm condition, standard alarm operates. When power is ON and it is an alarm condition, it is ignored. From the second alarm condition, standard alarm operates.
AL1d	Alarm latch and standby sequence	If it is an alarm condition, it operates both alarm latch and standby sequence. When power is ON and it is an alarm condition, it is ignored. From the second alarm condition, alarm latch operates.

Alarm output hysteresis [Program mode: A-HY]

Set the interval of ON/OFF alarm output.

The set hysteresis is applied to AL1 to AL4 and it is as below.

※E.g.) A-HY: 4

high limit alarm value: 800,
low limit alarm value: 200

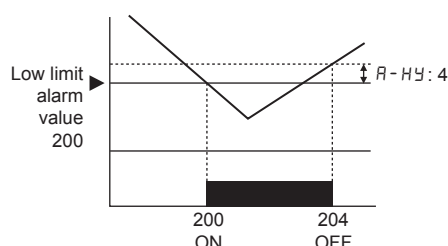
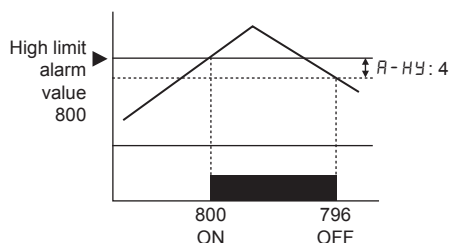

High/Low peak monitoring

[Monitoring mode: H.PEAK, L.PEAK]

This function is to save high/low peak to check the invisible abnormal condition of system at [H.PEAK] or [L.PEAK] in monitoring mode.

When the high/low peak is out of the temperature range, it displays HHHH or LLLL.

To initialize high/low peak, press the \boxtimes , \boxtimes keys at the same time for 3 sec at [H.PEAK] or [L.PEAK].

In this case, peak value is the present input value.

Error

Display	Descriptions	Troubleshooting
LLLL	Flashes when measured sensor input is lower than the temperature range.	When input is moved within the temperature range, it is cleared.
HHHH	Flashes when measured sensor input is higher than the temperature range	When input is moved within the temperature range, it is cleared.
bUr n	Flashes when the sensor is break or not connected.	Check temperature sensor connection.
E r r	Flashes when there is error to SV.	Check set conditions and re-set it.
E r r l	Flashes when $in-P$ setting and input type selection switch setting are not same.	Check input type.

A. Recorders

B. Indicators

C. Converters

D. Controllers

E. Thyristor Power Controllers

F. Pressure Transmitters

G. Temperature Transmitters

H. Accessories

KN-1000B

KN-2000W

■ User input range [Program mode: L-rG, H-rG]

When selecting analog input, you can set the input range for your purpose. Set low limit input value [L-rG] and high limit input value [H-rG] to limit the input range.

- Setting range
 - : Low limit input value [L-rG]+20%F.S.
 - < High limit input value [H-rG]

■ Parameter initialization

To initialize all parameter as factory default, supply the power to the product with pressing the **MODE** and **↵** keys at the same time and it enters initialization parameter.

Press the **MODE** + **↵** keys at the same time.

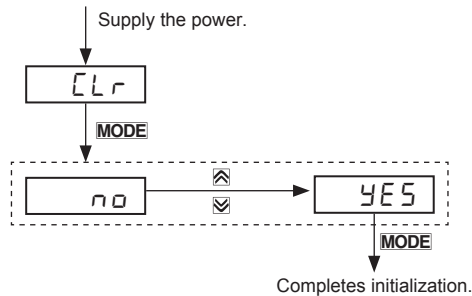

■ Input and transmission output extension

[Program mode: E4, I 0]

This function is to extend analog input and 4 to 20mA transmission output to 5% or 10% range.

Mode	Operation
0P	Outputs 4 to 20mA within analog input range.
5P	Outputs 3.2 to 20.8mA for 5% out of the analog input range.
10P	Outputs 2.4 to 21.6mA for 10% out of the analog input range.

※This parameter is displayed only for transmission output (4-20mA) model. But it is not displayed when selecting temperature sensor input.

■ Input correction [Program mode: I n - b]

This function is to correct the error occurring from a thermocouple, a RTD or analog input out of allowable error range of this unit.

This is also available to correct error when a sensor cannot contact the subject position by calculating the error temperature.

Variable temperature sensors have accuracy level. Because high accuracy type is expensive, standard thermocouples are generally used.

In this case, temperature sensor may occur error. By executing this function, you can get more accurate temperature.

When executing input correction function, you should measure the error from a sensor accurately. If the measured error is not correct, error may be greater.

(If I n5F = tUF, I n-b as atmospheric pressure input value not as input correction function. Refer to ■ Two unit function'.)

E.g.)When measured temperature is 4°C and actual temperature is 0°C. Set I n-b as -4, and display value is 0°C.

■ Transmission output scale

[Program mode: L.oUt, H.oUt]

For 4-20mA current output, this function is to set the display value for 4mA [L.oUt] and the display value for 20mA [H.oUt].

The interval between L.oUt and H.oUt is 10% F.S. If it is below 10%, it is fixed as 10% of SV.

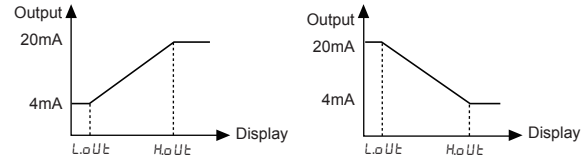

※Relation among input range, user input range, display scale, and transmission scale
The below figure is the example for 4 to 20mA.

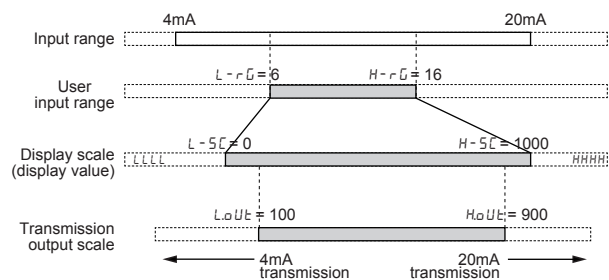

■ Two unit function [Program mode: tUF]

When connecting a pressure sensor, compound pressure which is below atmospheric pressure (0) is for vacuum as mmHg and which is atmospheric pressure or over it is for positive pressure as kg/cm².

Atmospheric pressure is 0kg/cm². When this unit does not display 0kg/cm², you can correct zero-point adjustment function.

When using two unit function, L-5C is fixed as -760.0

L-5C parameter is displayed but you cannot set this. You can set H-5C within 0 to 19999 range.

E.g.)When pressure range is -760.0mmHg to 3.000kg/cm², and pressure transmitter outputs 4-20mA, set the scale as H-5C: 3000, dP: 0.000.

This unit displays for 4mA input as -760.0, and for 20mA input as 3.000.

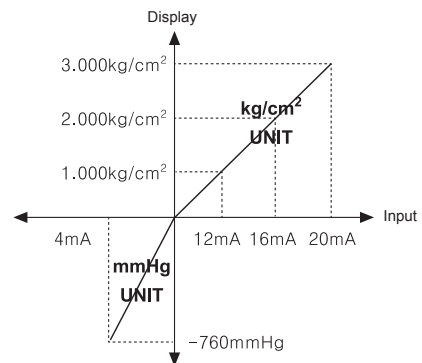

■ Display scale [Program mode: L - 5C, H - 5C]

For analog input, this function is to set (-19999 to 19999) for particular high/low limit value in order to display high/low limit value of measurement input. If measurement inputs are 'a' and 'b' and particular values are 'A' and 'B', it will display a=A, b=B as below graphs.

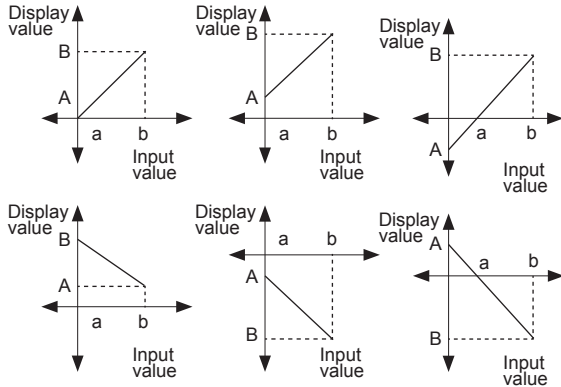

Display scale function is able to change display value for max./min. measured input by setting high limit scale [H-5C] and low limit scale [L-5C] in program mode.

※E.g.) Set high/low scale value (input range is 0 to 10V)

- L - 5C = 0.00
- H - 5C = 5.00, 10.00, 15.00, 10.00

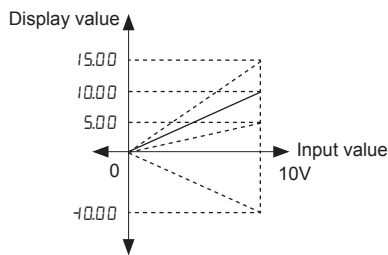

- L - 5C = 10.00, H - 5C = 10.00

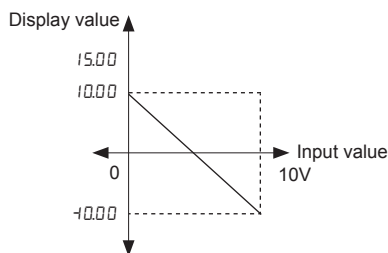

- L - 5C = -5.00, H - 5C = 5.00

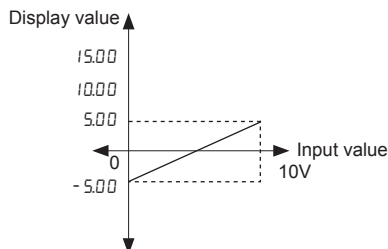

※When changing input type, high/low scale is changed as factory default.

■ Input special function [Program mode: I n, S F]

When selecting analog input, this function is to display the calculated actual value by square, root ($\sqrt{\quad}$), or two unit function (TUF) as display value.

Parameter	Functions	Graph	Applications
L I n	Outputs as input value		Standard characteristics. Input for linearity.
r o o t	Outputs the rooted ($\sqrt{\quad}$) input value		Used for measuring flows by pressure signal.
S q r r	Outputs the squared input value		Used for outputting differential pressure by flow signal.
t u f	Refer to ■ Two unit function'		

※Display value and mA output value for S q r r

$$\text{Display value} = \left\{ \frac{\text{Input value} - L - r G}{H - r G - L - r G} \right\}^2 \times (H - 5C - L - 5C) + L - 5C$$

(output value)

※Display value and mA output value for r o o t

$$\text{Display value} = \left\{ \sqrt{\frac{\text{Input value} - L - r G}{H - r G - L - r G}} \right\} \times (H - 5C - L - 5C) + L - 5C$$

(output value)

■ Digital filter [Program mode: n R u, F]

Moving average digital filter is able to stably display and output the noise from input line and irregular signals as software.

- Filter Setting range : 01 to 16 (when setting as 01, digital filter function does not run.)

※Display cycle is same when executing moving average digital filter.

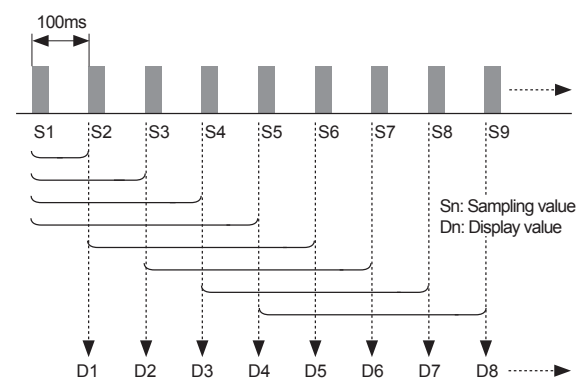

$$D1=S1, D2=S2, D3=S3$$

: Initial operation before averaging 4

$$D4 = \frac{S1+S2+S3+S4}{4}$$

$$D5 = \frac{S2+S3+S4+S5}{4}$$

$$D6 = \frac{S3+S4+S5+S6}{4}$$

$$D7 = \frac{S4+S5+S6+S7}{4}$$

$$D8 = \frac{S5+S6+S7+S8}{4}$$

A. Recorders

B. Indicators

C. Converters

D. Controllers

E. Thyristor Power Controllers

F. Pressure Transmitters

G. Temperature Transmitters

H. Accessories

KN-1000B

KN-2000W

■ Digital input [Program mode: $d1 - t, d1 - t$]

By digital input terminal [$d1 - t$] (terminal 6, 7) or digital input key [$d1 - t$] (D.IN3: + for 3 sec), one of three functions executes as the below table.

Function	Operation
$ALrE$ Alarm clear	When alarm is ON in RUN mode, it clears alarm forcibly. (It applies only for alarm latch, alarm latch and standby sequence options.) Alarm clear operates only when the value is out of the alarm value range. After clearing alarm, alarm operates its option normally. ※For the model without alarm output (KN-20□□W), this parameter is not displayed.
$Hold$ Display HOLD	Temporarily indicated value is stopped in order to check indicated value in unstable input.
$Zero$ Zero-point adjustment	Set preset display value as 0. This function is related with input correction [$in-b$]. When executing zero adjustment function in display value as 4, input correction value [$in-b$] is set as -4 automatically.

■ Alarm output for disconnecting input sensor [Program mode: $bUrn$]

When disconnecting input sensor, you can set the status of transmission output.

Parameter	SV	Transmission output (4-20 mA)
$bUrn$	on	20 mA+5% output
	off	4 mA-5% output

■ Display color [Program mode: $ELor / E-AL$]

This function is to change display color for occurring error, operating alarm automatically. User can check the status of this unit directly.

※Color of monitoring mode, program mode is red.

■ Lock [Program mode: $LoCk$]

It limits to check parameter set value and to change it.

	off	$LoC1$	$LoC2$
Program mode	●	◐	○
Monitoring mode	●	●	◐

- : Enable to check/set
- ◐: Enable to check, disable to set
- : Disable to check

※In $LoC2$, only $LoCk$ parameter displays in program mode.

◎ RUN mode and error display color [Program mode: $ELor$]

Parameter	Display color	
SV	RUN	Error
rEd	Red	Red
Grn	Green	Green
$YELo$	Yellow	Yellow
$r-rG$	Red	Green
$G-r-r$	Green	Red

◎ Alarm display color [Program mode: $E-AL$]

This parameter is displayed only for the alarm output models (KN-22□□W, KN24□□W).

- The number of set digit is same as the number of alarm output.

[2 alarm outputs (KN-22□□W)]



[4 alarm outputs (KN-24□□W)]



- Set color for each alarm.
It changes as $r \rightarrow G \rightarrow Y \rightarrow r$ in turn.

※E.g.) S: Press any one among the , , keys.

	RUN mode color is green.
	<ul style="list-style-type: none"> ① AL-1 is ON, display is green → yellow. ② AL-2 is ON, display is yellow → red. ③ AL-3 is ON, display is red → green. ④ AL-4 is ON, display is green → red.

- When alarm is cleared, or two alarms operate at the same time, the latest alarm's color is applied.
- When error occurs [$HHHH, LLLL, bUrn, Err, Err1$] during alarm, the set color of $ELor$ is applied.

■ Temperature unit [Program mode: $Unit$]

Temperature unit (°C/°F) is selectable. When changing temperature unit, user input range, display scale, output scale, alarm SV are initialized. You should set the parameters again for your purpose.

※When selecting analog input, temperature unit [$Unit$] parameter is not displayed.

■ Front display unit [Program mode: $dUnit$]

When selecting analog input, select the unit (% , °C , °F, not display) of display value.

※When not displaying unit, set off and it turns OFF all indicators.

※When selecting temperature sensor input, this parameter [$dUnit$] is not displayed.

Communications

■ Communication set

[Program mode: *Addr, bAud*]

You can set communication address [*Addr*] and communication speed [*bAud*] for RS485 communication.

■ Communication write enable/disable

[Program mode: *ENR*]

You can set to enable [*ENR*] or disable [*diSR*] or writing parameter setting by RS485 communication.

■ Communication manual

Refer to communication manual for RS485 communication.

Visit our web site (www.autonics.com) to download communication manual and software [Integrated device management program (DAQMaster)].

■ Integrated device management program (DAQMaster)

DAQMaster is the integrated device management program to set parameters and manage monitoring data.

Visit our website (www.autonics.com) to download user manual and integrated device management program.

< Computer specification for using software >

Item	Minimum requirements
System	IBM PC compatible computer with Intel Pentium III or above
Operating system	Microsoft Windows 98/NT/XP/Vista/7/8/10
Memory	256MB or more
Hard disk	More than 1GB of free hard disk space
VGA	1024×768 or higher resolution display
Others	RS-232 serial port (9-pin), USB port

< DAQMaster screen >

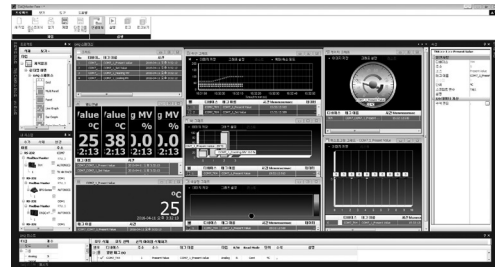

■ Communication specifications

Item	Specifications
Communication method	RS485 2-wire half duplex
Communication speed (BPS)	19200, 9600, 4800, 2400, 1200
Converter	Converter built in RS232
Max. connections	32 units
Communication distance	Max. 1200m (within 700m recommended)
Protocol	Modbus 1.1 RTU
Parity	None
Stop Bit	1-bit
Data length	8-bit

■ Application of system organization

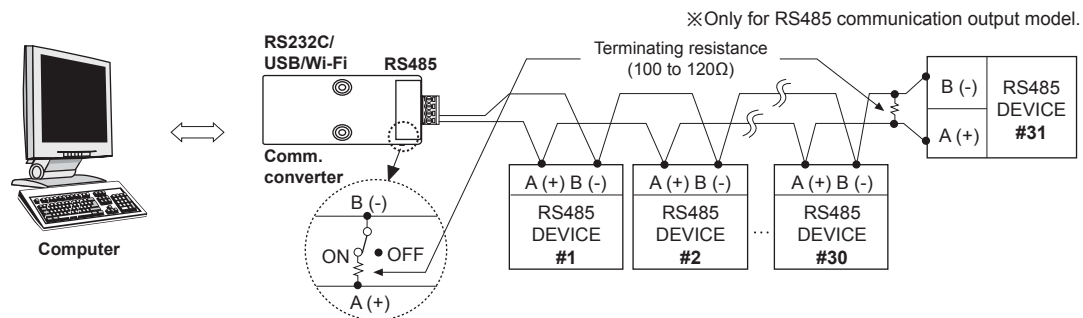

※ It is recommended to use Autonics communication converter;
 SCM-WF48 (Wi-Fi to RS485-USB wireless communication converter, sold separately),
 SCM-US48I (USB to RS485 converter, sold separately), SCM-38I (RS232C to RS485 converter, sold separately),
 SCM-US (USB to Serial converter, sold separately).
 Please use twisted pair wire, which is suitable for RS485 communication, for SCM-WF48, SCM-US48I and SCM-38I.

A. Recorders

B. Indicators

C. Converters

D. Controllers

E. Thyristor Power Controllers

F. Pressure Transmitters

G. Temperature Transmitters

H. Accessories

KN-1000B

KN-2000W

KN-2000W Series

Monitoring Mode

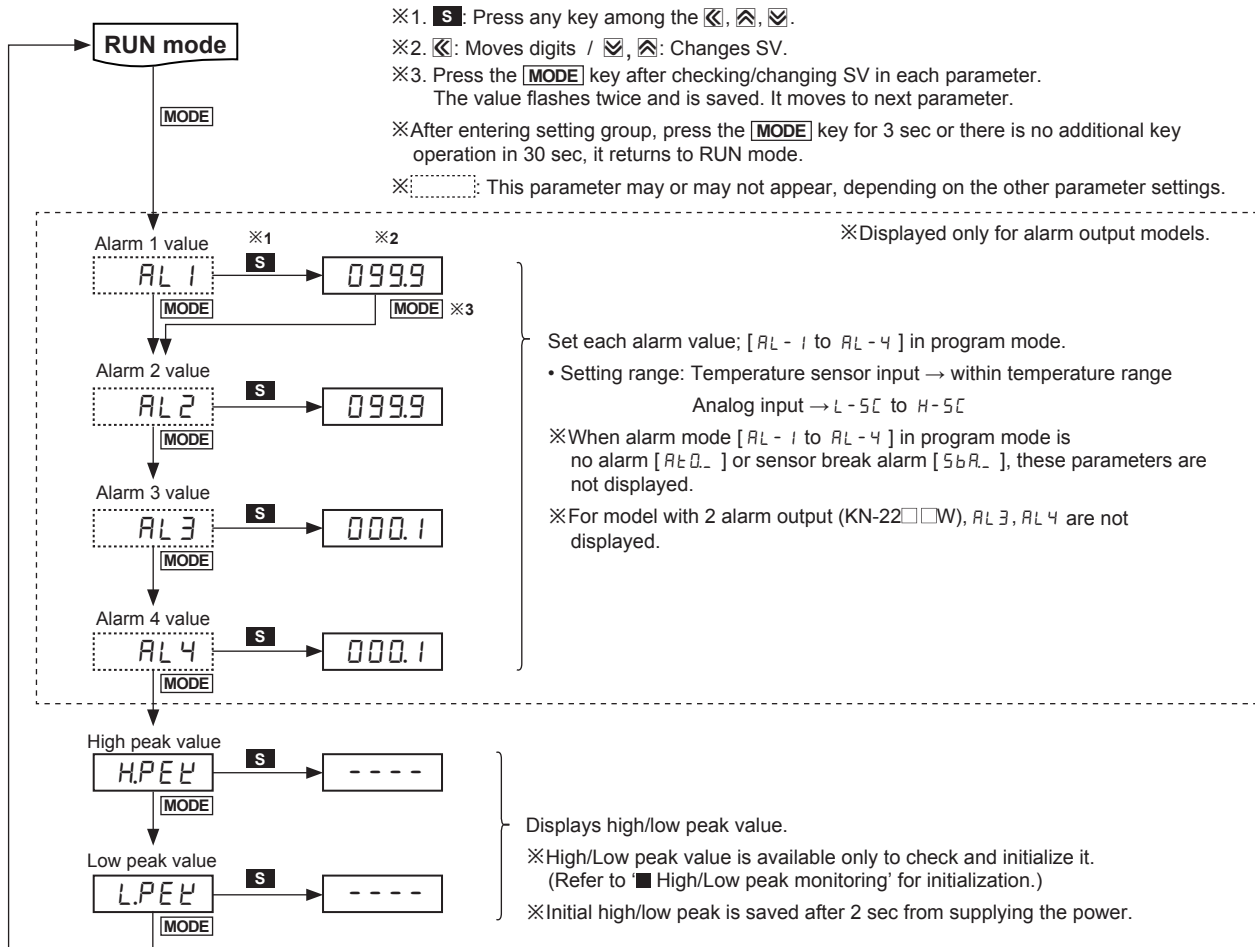

Program Mode

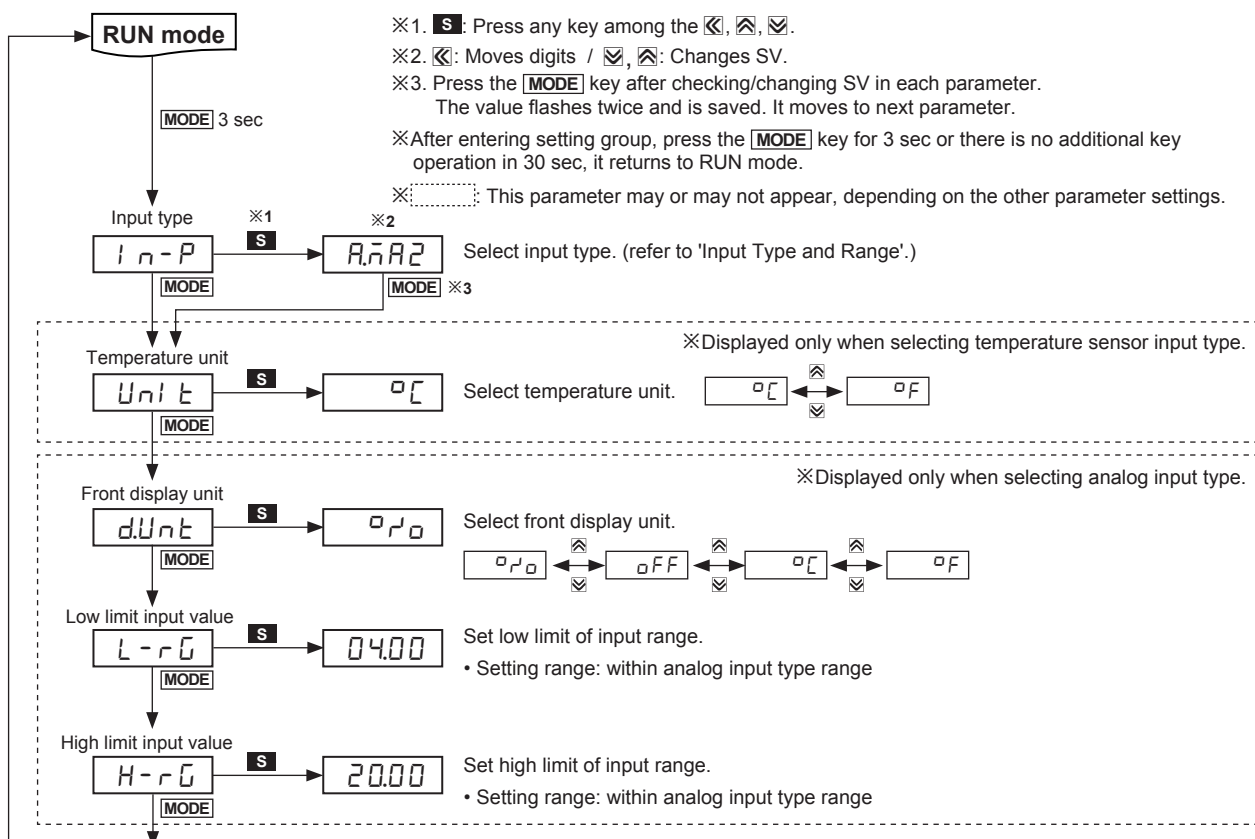

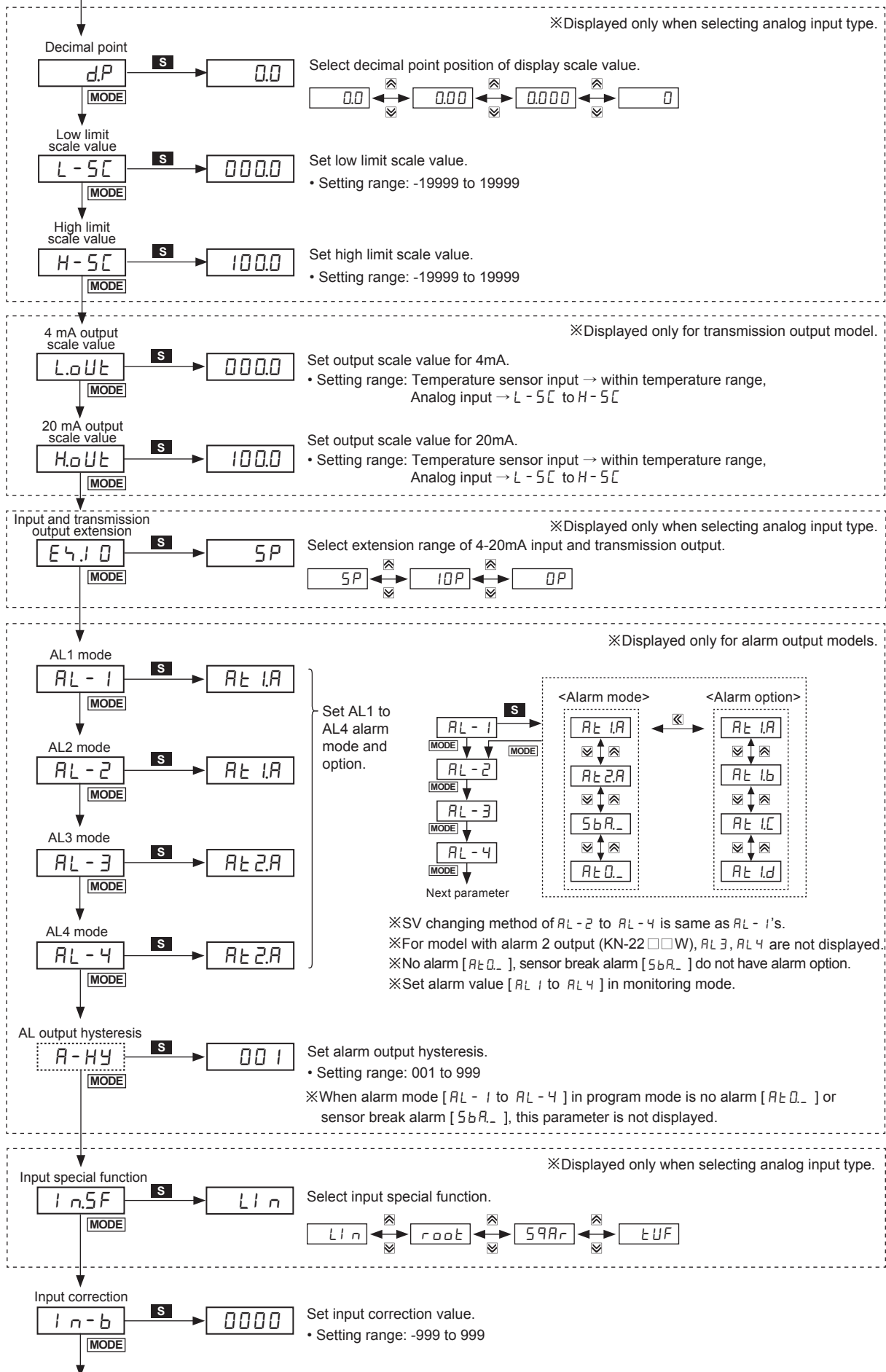

- A. Recorders
- B. Indicators
- C. Converters
- D. Controllers
- E. Thyristor Power Controllers
- F. Pressure Transmitters
- G. Temperature Transmitters
- H. Accessories

- KN-1000B
- KN-2000W

KN-2000W Series

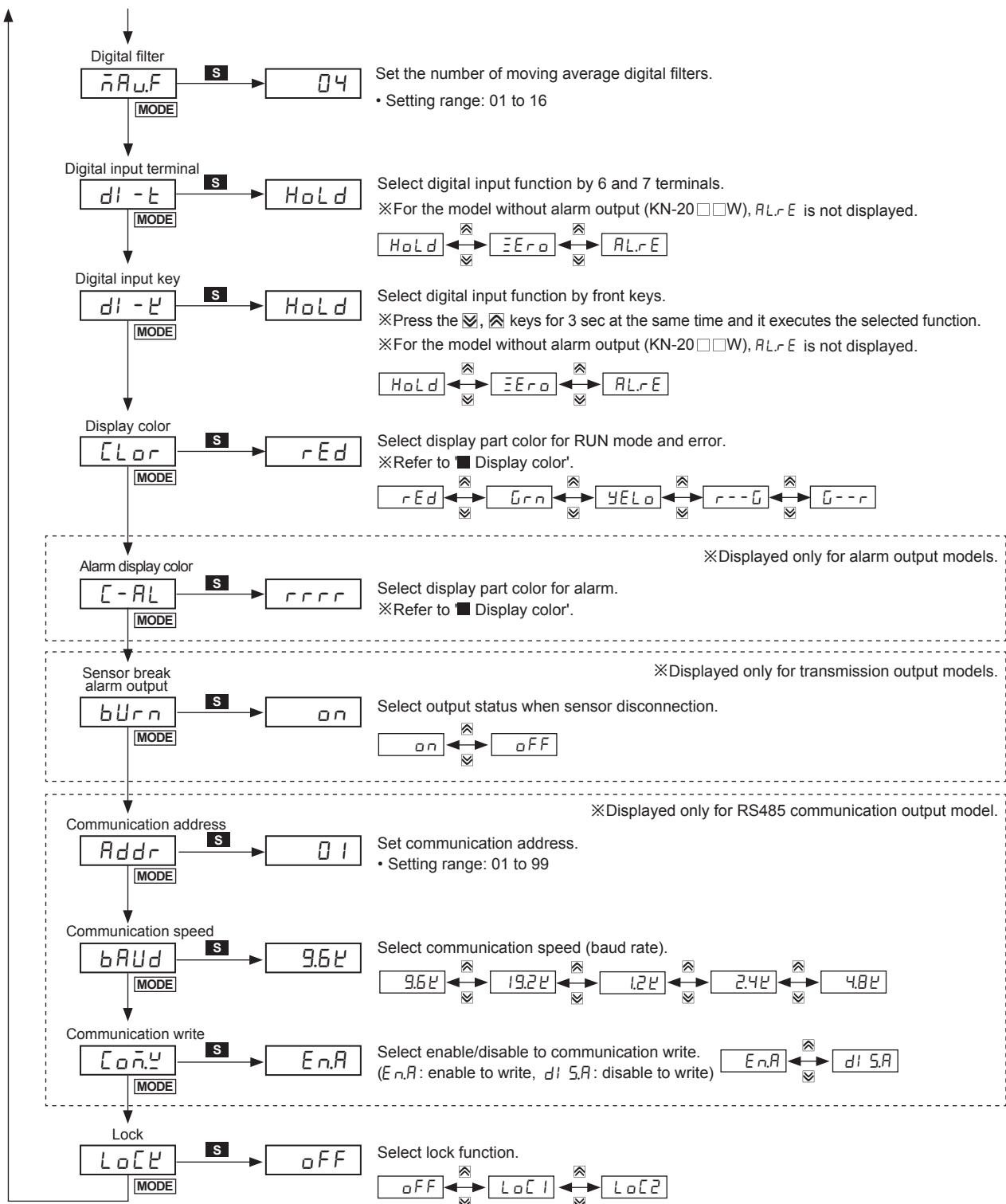

Factory Default

■ Monitoring mode

Parameter	Default	Parameter	Default	Parameter	Default
AL1	099.9	AL3	000.1	HPEL	----
AL2	099.9	AL4	000.1	LPEL	----

■ Program mode

Parameter	Default	Parameter	Default	Parameter	Default	Parameter	Default
in-P	ARAR2	LOUt	0000	inSF	Lin	Addr	01
Unit	°C	HOUt	1000	in-b	0000	bAUD	9.6L
dUnit	°F	EH0	5P	nAUF	04	ConL	EnA
L-rG	0400	AL-1	At1A	di-t	HoLd	LoCL	oFF
H-rG	2000	AL-2	At1A	di-L	HoLd		
dP	00	AL-3	At2A	CLor	rEd		
L-SC	0000	AL-4	At2A	C-AL	rrrr		
H-SC	1000	A-HY	001	bUrN	on		

Proper Usage

- Do not use the unit outdoors. Failure to follow this instruction may result in shorten the life cycle of the unit, or electric shock.
- For connecting the power, use a crimp terminal (M3.5, max. 7.2mm).
- The connection of this unit should be separated from the power line and high voltage line in order to prevent inductive noise.
- Install a power switch or a circuit breaker to supply or cut off the power.
- Switch or circuit breaker should be installed nearby users for convenient control.
- Do not use this unit near the high frequency instruments (high frequency welding machine & sewing machine, large capacity SCR controller).
- When supplying input, if HHHH or LLLL is displayed, measured input may have problem. Turn off the power and check the line.
- This product may be used in the following environments.
 - ① Indoors
 - ② Pollution degree 2
 - ③ Altitude max. 2,000m
 - ④ Installation category II
- Failure to follow these instructions may result in product damage.

A. Recorders

B. Indicators

C. Converters

D. Controllers

E. Thyristor Power Controllers

F. Pressure Transmitters

G. Temperature Transmitters

H. Accessories

KN-1000B

KN-2000W